



#43.949 Winch lock



#43.949 Winch lock



Showing winch lock #43.949 with hatch fastener #43.975 and lift handle #43.974

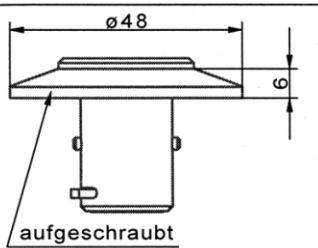
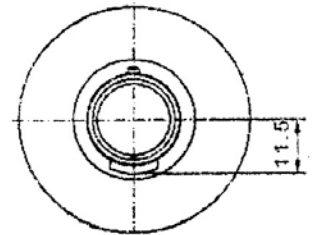
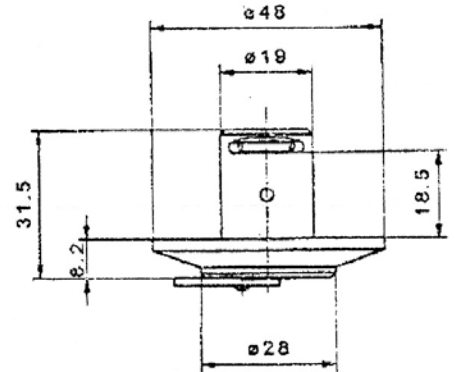
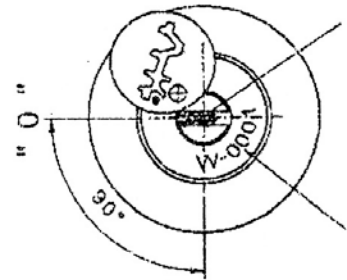

Harken
Lewmar

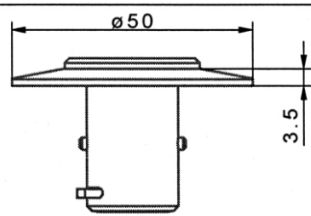

• Andersen
• Barlow

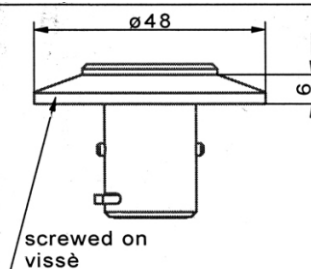

Harken
Lewmar

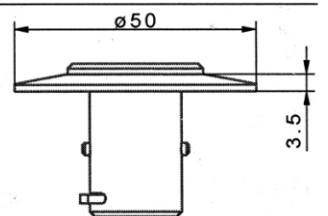

• Andersen
• Barlow

#43.949 Winch lock comes with screw-on collar; placing depending on the brand of winch.



IZERWAREN
Order
number

43.687K **Hatch cam with key** 316 stainless steel
finish: satin polished
outside diameter body: 28 mm
cut out: 22.5 mm
cam: long 1 3/4"
cam depth: adjustable 3/4"
depending on type of cam. (See below)

43.999 **Strike plate #43.999**
110 x 40 mm

43.998 **Strike plate flush** 43.998
64 x 18 mm
316 Stainless steel

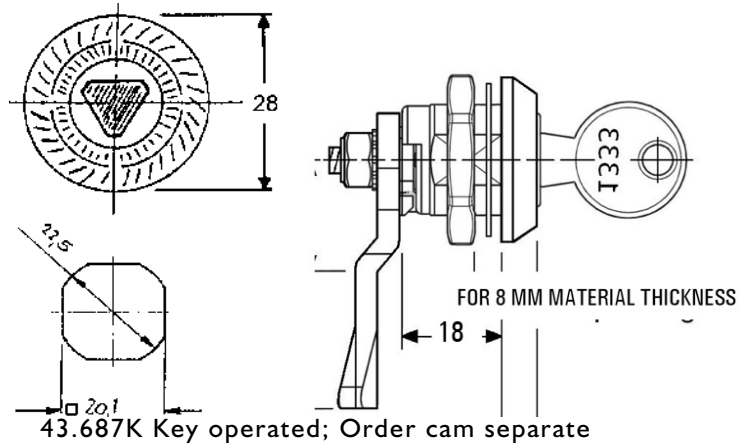

43.687K Key operated; Order cam separate

Cams:

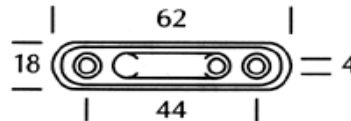
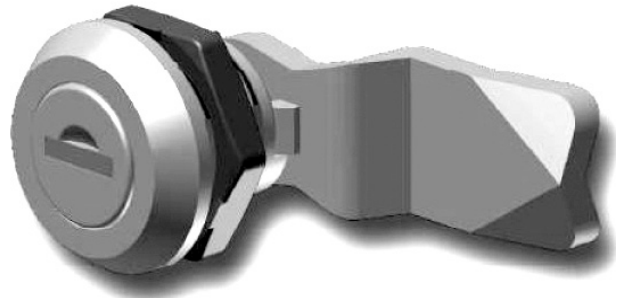
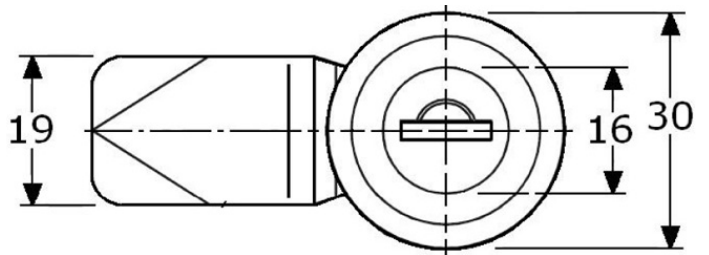
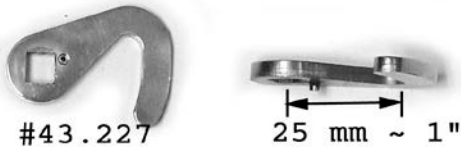
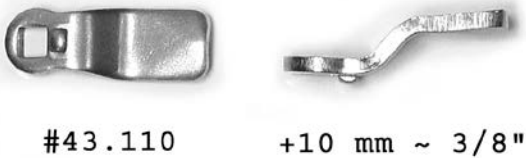

Strike plate flush #43.998

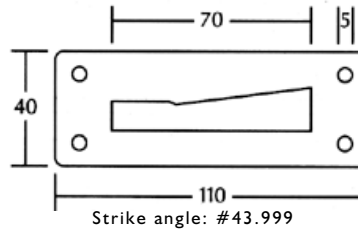

Strike angle: #43.999

For other cam locks see website / catalog / deck hardware / 316 stainless steel hatch fasteners / Pages 4-3-0-0 a. f.

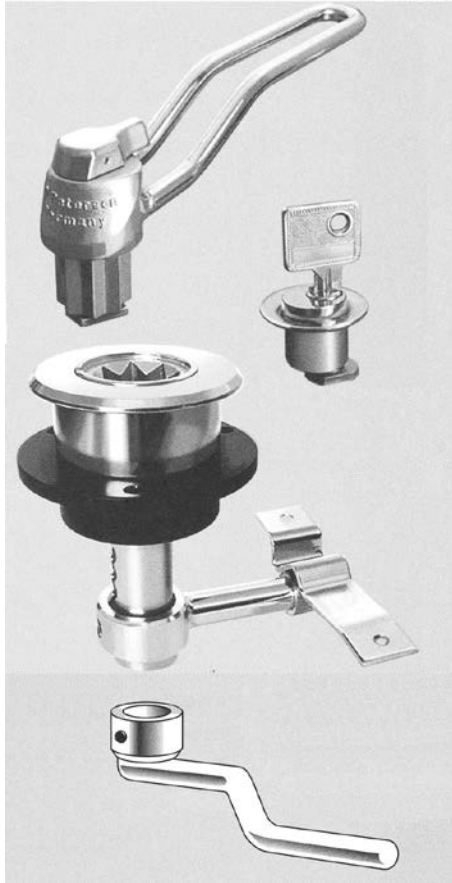

Showing #43.926 Winch lock with hatch fastener #43.975 with roller bearing cam + strike and lift handle #43.974

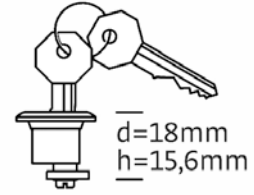

#43.1354

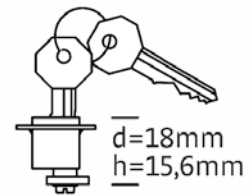

#43.926

